

Mag Max

Magazine color changer with color Cartridge
Software version V4.34

Functional description Mag Max Mk2



Fabrication and Marketing
Licht-Technik

Hagenbach & Grill

Osterwaldstr. 9-10 80805 München
Tel. 089-360528-0 Fax 089-360528-30

last updated on: 13/10/17 Rev.: 2.16

Caution! Operate the device only after having read and **understood** operating instructions!

Mag Max Mk2 color changer

The successor **Mk2** differs from its predecessor only in the outward form. The reason for changing is an cartridge adaptation to the **Mag Vader** (dimmer shutter and color changer in one device). Now it is possible to use the same cartridge in **MagMax** and **MagVader**. For example a cartridge with color code „red“ fits to the devices Mag Max Mk2 250 and Mag Vader 200.

The color cartridge can be exchanged within a few seconds. The breaks for changing and setting up for the next show can be **shortened** considerably.

After putting in the color cartridge, the color changer will **automatically** scan the string and memorise the individual positions of the color tape. There is no more need for any further programming of the positions. The individual positions of the colors are detected by the aluminium markers on the string which move through a light sensor. Special (longer) markers are at the first and the last frame to recognize the begin and the end.

The controlling is done by **DMX512 (USITT)**. The position, the speed and the fan intensity (noise reduction) can be triggered by DMX.

The string can be moved in **linear** and **frame-by-frame** mode. In linear mode every position on the foil can be reached. In frame-by-frame mode only the full color frames are responsive. A **dark color mode** is possible for especially sensitive colors. A dark color frame has the double length of a normal frame and will be moved in slowmotion from the beginning of the frame to its end. The advantage is a better heat distribution on the foil, so that the gel has a longer lifetime.

Speed can be programmed as a **speed** or **time** function. Speed control defines the speed with which the color tape should move. Time control determines a time in which the next move is to be done.

This time can be programmed from 1s to 120min. via DMX. This allows very slow movement to make sunrise effects for example but also very quick color changes (20 colors in 3.5 seconds for MM200) can be realized.

The **fan intensity** can be determined from 0% to 100% to avoid noise if necessary.

The built in **32-Bit Processor** provides a high throughput of the computer, quick positioning and uncomplicated handling. Even when triggering several color changers the precise control system provides an absolute synchronous movement. Thus horizon crossfadings can also be realised with several color changers on a large width.

Because of the absolute value device, the device doesn't need to make any **initialisation runs** after power up.

The lighted **LCD display** (the light can be switched off) leads the user in plain text instructions through the various programming steps. The instructions are available either in english or german language.

We would like to express our special thanks to Max Keller, Gundram von Löffelholz and Tobias Löffler, whose ideas, creativity and criticism represented a valuable contribution in the development of the MAGMAX and the MAGMAX MkII.

Table of content

Mag Max Mk2 color changer.....	3
Safety and operating instructions.....	5
Dimensions of color tape.....	7
Positioning of the aluminium markers.....	8
Dimensions of strings of Licht-Technik color changers.....	10
Inserting the foil strip into the cartridge.....	11
Cabling.....	12
Inserting the cartridge into the device.....	13
Removing the cartridge of the device.....	13
Getting started.....	14
User interface.....	15
Display lighting ON/OFF.....	15
Checking basic parameter.....	16
Setting to default values (new in Version 4.18).....	16
The different modes.....	17
P01 DMX-Adress position.....	19
P02 DMX address speed.....	20
P03 DMX adress fan intensity.....	21
P08 DMX addresses together or seperately.....	22
P09 Dark color mode speed.....	23
P10 Setting, Resetting and controlling of the dark colors.....	24
P11 Move mode MagMax.....	25
P12 Speed mode MagMax	26
Time conversation table time drive mode.....	27
P13 Maximum moving time for time drive mode.....	28
P20 Internal Speed of color changer.....	29
P22 Internal fan intensity.....	30
P30 Displaying the DMX value.....	31
P31 DMX Jitter compensation.....	32
P32 Selecting the user language.....	33
P34 Reverse DMX time drive.....	34
P35 Unit number (Netspider only).....	35
Technical data.....	36
Factory presettings.....	37
Error Messages / Malfunctions.....	38
Warranty.....	39
Further information.....	39
Declaration of conformity.....	40

Safety and operating instructions

The **MAG MAX MkII** Color Changer must only be operated in the operating position provided for this purpose. Operating position is vertical (LCD display is in bottom position) with max. +/- 60 degree.

Admissible ambient **temperature**: 0..55 °Celsius.

The device is getting very **hot** during operation because of the heat of the lamp. Let it cool for at least 1 hour before touching.

The lamp must not shine direct onto the color changer. This means the diameter of the color changer must not be smaller than the diameter of the head. For example it is not allowed to use a MAGMAX 200 in front of a lamp with a diameter of 300mm.

Never seize inside the device, because the fan may run.

The top and bottom vents must not be blocked or covered.

The equipment is designed to be used in dry and clean rooms.

The color changer must be kept dry. In case water condensation a waiting period of up to 2 hours is necessary until the acclimatisation is reached.

„PAR“ spotlights without dispersing lens are not suitable for being used with color changers.

Make sure that the maximum load of the fastening spigots will not be exceeded by the additional weight of the color changer.

Check fixing of the color changer at the lamp,

Always use a safety belt for the device itself and the cartridge.

Check the fixing of the cassette.

Power supply of *Licht-Technik* color changers via the datapower input must only be realized via power supplies authorized by us (safe electrical separation from the mains).

When it has to be assumed that a safe operation is no longer possible, the equipment must be switched off immediately and be secured against unintended operation.

This is the case when

- the equipment shows visible damages
- the equipment is no longer functional
- parts of the equipment are loose or slackened
- connecting lines show visible damages

Before starting the equipment the user must check the usefulness of the device for its intended use. In particular, *Licht-Technik* shall decline any liability for damages of the equipment as well as for consequential damages resulting of the device being used inappropriately, of inexpert installation, incorrect starting and use, and of noncompliance with the valid safety regulations.

Dimensions of color tape

We recommend filters of Rosco™ type Supergel©

Please cut your gels to fit on the rolls in the same way like the gels is on original gel roll. Your can avoid disturbing movement noise and a excessive wear of the foil.

At standard length of each frame you can put in the amount written in the table. The maximum number of colors depends on the size of the device. The **Mag Max** can memorise the individual positions for a maximum of 47 aluminium markers (if you like to realize special effects like sunrise or rainbow). At standard length of the individual foil strips the following foil composition is resulting thereof. However, at any time it is possible to insert a lesser amount of foil strips. Minimum is 2 (the begin and the end marker).

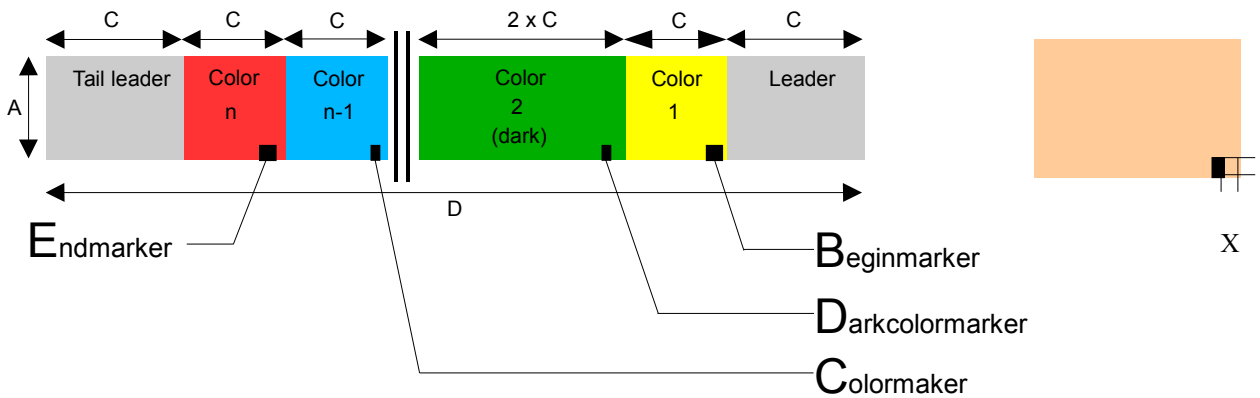

Type	Color code cartridge	Height A	Color Length C	Total length D	Max colors
MM 200 Mk2	Green	225	305	6710	20
MM 200 Mk2 – 25	Green	225	305	8235	25
MM 250 Mk2	Red	276	370	8140	20
MM 300 Mk2	Black	320	440	9680	20
MM 300 Mk2 – 25	Black	320	440	11880	25
MM 350 Mk2	Yellow	370	490	9800	18
MM 430 Mk2	Blue	450	550	9900	16
MM 500 Mk2	Grey	530	630	10080	14

All dimensions in mm!

To use a color in dark color mode it is necessary to double the length C. The total number of colors is reduced accordingly.

White Diffusion proved itself extremely efficient as leader and tail-leader, since this type of material is fitting very closely and can thus compensate any inaccuracies resulting from the tape-in procedure. We recommend to use a transparent adhesive tape with high temperature stability for this purpose.

The positioning of the aluminium markers is described as follows.

Positioning of the aluminium markers

The color changer can recognize the individual color positions by means of the attached aluminium markers. Thus the frames can be exactly positioned or even be corrected should the foil strips expand because of the heat.

The minimum number of markers is 2 (Begin and endmarker).

The markers must consist of an opaque material (aluminium). They can also be ordered from our company.

Positions of the markers on the gel:

Type	Distance x in mm		
	(dark-) colormarker	begin marker	endmarker
MagMax™ Mk2 200	65	80	35
MagMax™ Mk2 200 – 25	65	80	35
MagMax™ Mk2 250	65	80	35
MagMax™ Mk2 300	65	80	35
MagMax™ Mk2 300 – 25	65	80	35
MagMax™ Mk2 350	80	95	40
MagMax™ Mk2 430	80	95	40
MagMax™ Mk2 500	80	95	40

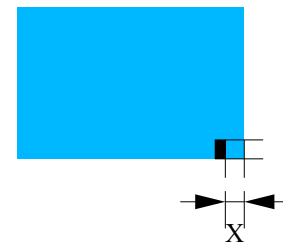

At the bottom end, the marker has to be placed concisely with the bottom end of the gel!

Dimensions of the marker: Begin- and endmarker: 25 mm x 25 mm
 Colormarker: 6,5 mm x 25 mm vertical
 Dark color marker: 13 mm x 25 mm vertical

Beginmarker: It has to be attached to the beginning of the first color so that the beginning of the marker (right side) is in the light sensor when the first color is centered in the cartridge.

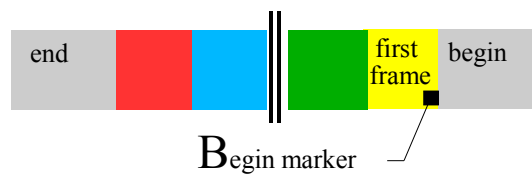

Endmarker: It has to be attached to the beginning of the last color so that the end of the marker (left side) is in the light sensor when the first color is centered in the cartridge.

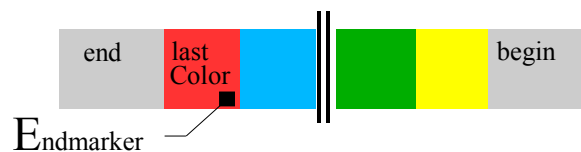

Colormarker: The Colormarker has to be taped in vertical position at the beginning of each frame. It must be positioned precisely in the sensor when the respective color is centered in the cartridge window.

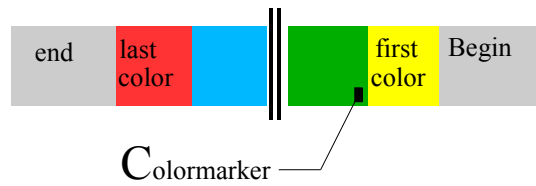

Dark color marker: The dark color marker has to be taped in vertical position at the beginning of a dark color frame. It must be positioned precisely in the sensor when the respective color is centered in the cartridge window. The first and the last color of the string can not be taped with a dark color marker because these frame have the begin and end marker.

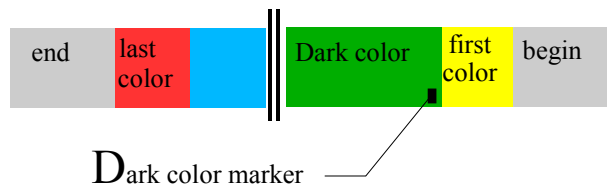

The markers can also be taped to the front or rear side after the color tape has been inserted into the cartridge.

Dimensions of strings of Licht-Technik color changers

(All dimensions in mm!)

Sizes of markers: Begin- and Endmarker: 25 x 25mm
 Colormarker: 6,5 x 25mm vertical
 Darkcolormarker: 13 x 25mm vertical

At the bottom end, the marker has to be placed concisely with the bottom end of the gel!

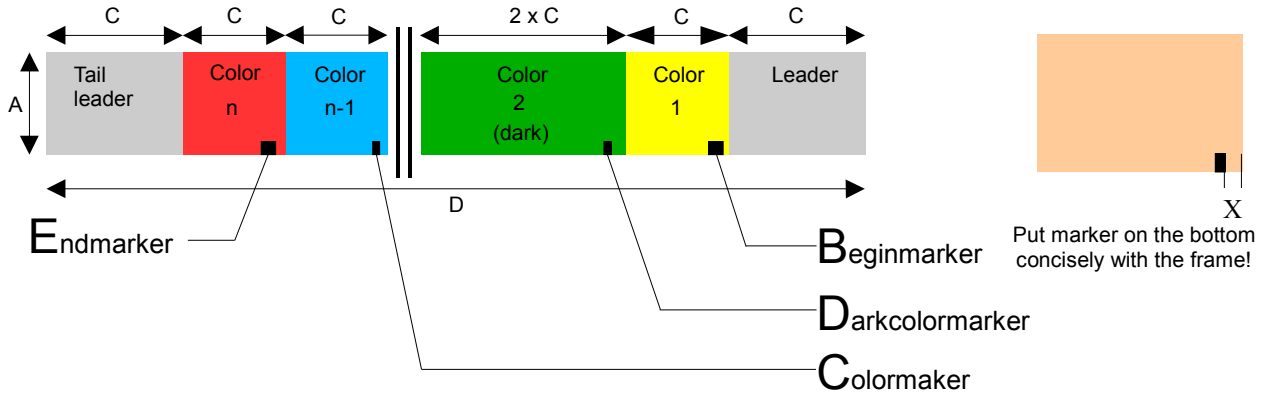

MagMax™							Position x			Revolutions for foil tensioning
Type	Color-code Cartridge	Height A	Color Length C	String Length D	Max. Colors	Color marker	Begin marker	End marker		
MM200		216	280	6160	20	50	80	15		
MM250		275	380	7980	19	70	75	45		
MM300		318	450	9000	18	70	75	45		
MM350		358	480	8640	16	65	75	45		
MM430		450	530	8480	14	60	75	20		
MM500		520	640	8960	12	65	80	30		
MM500XL		700	640	8960	12	65	80	30		
MM8-Lite		700	530	8480	14	60	75	20		

MagMax™ Mk2		MagVader		Position x							Revolutions for foil tensioning
Type	Color-code Cartridge	Height A	Color Length C	String Length D	Max. Colors	Color marker	Begin marker	End marker			
	MV175 Event	206	280	7560	25	50	50	50	5-6		
MM200 Mk2	Green	225	305	6710	20	65	80	35	5-6		
MM200 MK2-25	Green	225	305	8235	25	65	80	35	6-7		
MM250 Mk2	MV200	276	370	8140	20	65	80	35	5-6		
MM300 Mk2	MV250	320	440	9680	20	65	80	35	10-11		
MM300 Mk2-25	Black	320	440	11880	25	65	80	35	12-14		
MM350 Mk2	MV300	370	490	9800	18	80	95	40	10-11		
MM430 Mk2	MV350	450	550	9900	16	80	95	40	12-14		
MM500 Mk2	MV430	530	630	10080	14	80	95	40	20-22		

CC-Serie		SH-CC		Use dark color markers only with Version 2.1 (CC) respectively 1.1 (SH-CC) or higher							Revolutions for foil tensioning
Type	Color-code Cartridge	Height A	Color Length C	String Length D	Max. Colors	Color marker	Begin marker	End marker			
CC150		174	215	6880	30	40	30	30			
CC175		192	240	7680	30	40	30	35			
CC200	SH-CC185	225	305	9760	30	50	50	50			
CC250		276	370	9990	25	65	50	50			
CC270	SH-CC270	276	370	9990	25	65	50	50			
CC350	SH-CC325	370	465	9300	18	75	60	50			
	SH-CC460	498	580	10440	16	75	60	50			

MagMax™ Cyclo Series		Use dark color markers only with Version 2.1 or higher							Revolutions for foil tensioning
Type	Color-code Cartridge	Height A	Color Length C	String Length D	Max. Colors	Color marker	Begin marker	End marker	
See Cyclo Series manual									

The revolutions for tensioning should be a reference point valid for new gels and the maximum of color frames!

Inserting the foil strip into the cartridge

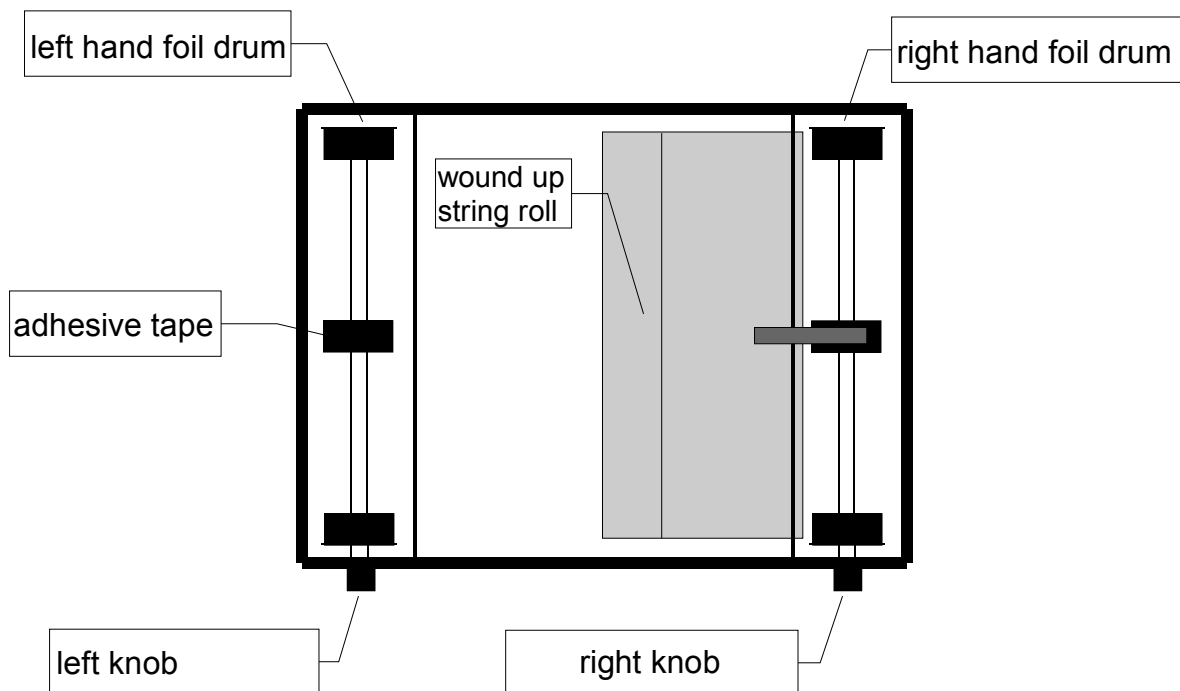

Important!

Always fix the string only on the middle drum. Never on the bottom or top drums!!

Wind up the foil strip in a way that the open end shows the leader. Insert the colour tape, as indicated, into the cartridge and, by means of left-hand knob, wind the complete color tape onto the right-hand foil drum. Now center and tape the tail-leader on the left-hand foil drum. Tense the foil strip by retaining the right-hand stop button and turning the left-hand knob against the clockwise direction.

At the older model MagMax (angular design) it is just the way around:

Start putting in the foil with the tail leader onto the left drum. The left button is the stop button and the right button must be turned in clockwise direction to tense the foil.

Observe the number of revolutions for tensioning in the table on page ! For counting the revolutions the screw at the knob can be a help. The revolutions should be a reference point valid for new gels and the maximum of color frames!

Note: Too much tension is the reason for failure and broken springs.

Important: Check whether all of the individual aluminium markers are moving through the sensor.

Cabling

The standardized DMX-Signal is based on industrie's RS485 Interface. It is designed for maximum lengths up to 1200m. This length is under condition in theatre or studio normally not possible. As a result of internal tests we recommend a maximum length of 200m (**only DMX, 5PIN**).

The maximum length of a Output (**Data Power, 4PIN**) must not exceed 80m because of the voltage drop.

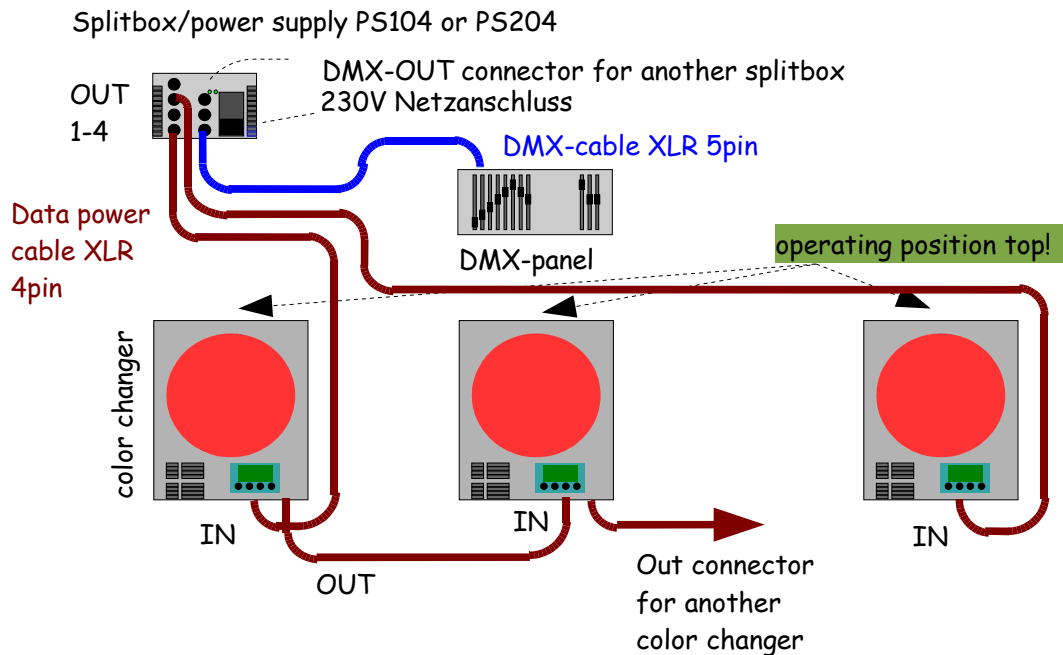

Connect the light mixer panel and the Splitbox PS104/PS204 with a 5PIN XLR-DMX-cable. The splitbox is provided with a DMX out jack for connecting additional splitboxes. At each of the four DATA Power outputs for the devices a maximum of 4 color changers can be connected. However, the total number of Color Changers per splitbox must not exceed 16 color changer (PS204) or 8 Color Changer (PS104) respectively.

The last device of a serie should be connected with a terminating impedance (470 Ohm). It is plugged into the OUT connector of the last device of a row.

Inserting the cartridge into the device

Always put the cartridge into the device when it is **switched on**. If necessary, wait until the device indicates "insert cassette".

The cassette is simply put in, by inserting the cartridge into the shaft. A clicking indicates the mechanical locking.

At the older "angular" model, the locking is done by turning the knob.

Important! Never change the colour cartridges when the equipment is switched off! Doing so may result in malfunctions or torn foil strips.

Removing the cartridge of the device

Always pull out the cartridge when the device is **switched on**. Push the cartridge down and pull on the lever. The cartridge is unlocked and can be pulled out. See picture:

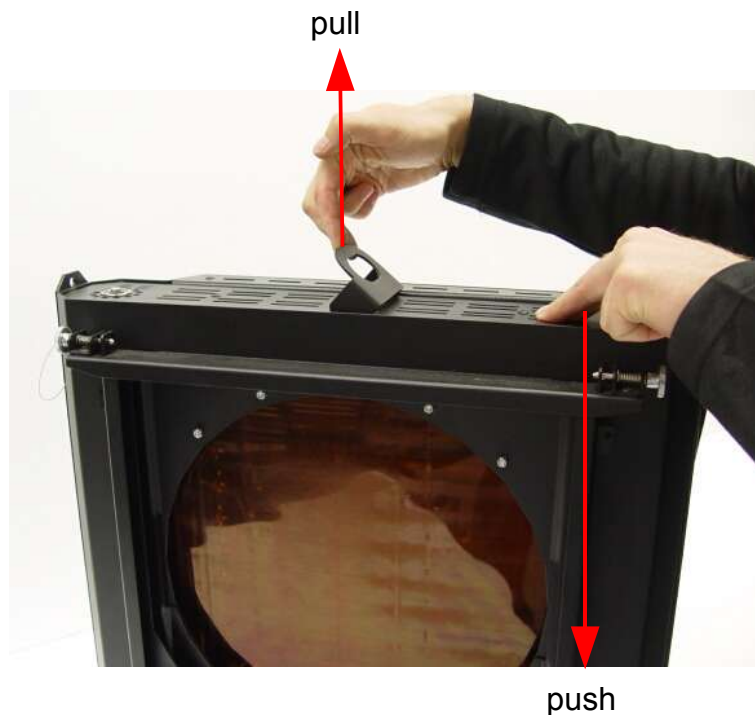

Getting started

Important! Never change the colour cartridges when the equipment is switched off! Doing so may result in malfunctions or torn foil strips.

Cable the color changer according to its wiring diagram. Refer to page 12

Compose the foil strip and insert it into the cartridge (see page 11).

Switch the color changer on - without the colour cartridge inserted - and wait until the message INSERT CARTRIDGE is displayed.

Set the color tape of the cartridge to its centre color frame, insert the cartridge **and** close it. Wait until the colour changer has finished memorizing the individual colors and scanning the complete cartridge. During the memorizing process of the colours the first line will display the color number and the second line the value of the internal absolute value device.

When the color tape is too long, ERROR 41 will be displayed. If necessary, shorten the color tape down to its maximum length and reinsert the cartridge. This message also occurs if the tape was not centered when putting in.

The second line of the display will show the adjusted DMX address and the DMX value transmitted by the light adjusting panel. (You will see values from 0..255 the full DMX 8bit value)

The only thing left to do is to adjust the DMX address (menu P01, *position of color tape*, refer to page 19) after that then you can position the color changer via your light adjusting panel.

For further programming possibilities, please refer to the following pages.

User interface

Moving text with type of device, software version and service telephone number

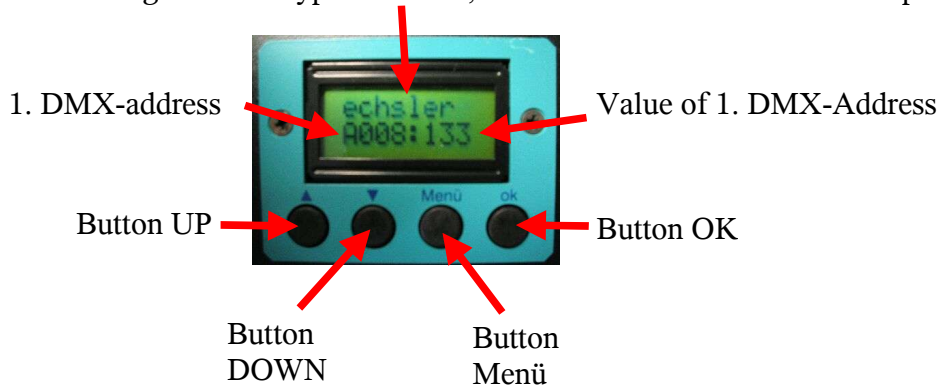



Display lighting ON/OFF

During normal operation mode the LCD backlight is switched off to avoid a disturbing light. Only if an error occurs or during programming the light will be switched on automatically. The user can also switch it on manually to see what is indicated.

Condition: Color changer is on working level (default state)

Operation:





-  depress. Display light **ON**
-  depress. **Display light OFF**

Checking basic parameter

With this function you can quick check some basic parameters. Here you can get an quick overview of what is programmed.

Condition: Color changer is on working level.

Operation:

-  depress. check number of stored color frames. You can see the number in second line of the display e.g.:
FRAME:11
-  depress again. check parameters P01..P03. e.g.
P01: 001
023 002
-  depress again. check marked dark-colors. Displayed are only dark colors.
dark: 01 03 08 16 17
-  depress again. Address and DMX-value is displayed again e.g.
A001:023
You are back at working level.

Setting to default values (new in Version 4.18)

With the following handles the equipment can be put back to factory presettings (refer to page 37). This is an interesting feature for rental houses which can reset the device after a order.

Operation:

Power off MagMax first

-  depress and hold.

Power on MagMax.

-  release. Display shows ok for presets

 Ok

if you like to store default values
any other key for doing nothing

The different modes

The color changers are well prepared for customers desires regarding the control.

The string consists of different color frames glued together by the user. To improve position accuracy a marker should be put on every frame. With the help of the aluminum marker the positions of the frames can also be corrected when waving (heat!). This correction is only possible in frame-by-frame mode. In this mode only full frames can be positioned. If you like to do intermediate positions you should switch to linear mode in menu P11 (page 25).

When triggering in linear mode the length of the string is divided in 256 steps (8-Bit, one DMX-channel). For example: The smallest step on a tape with 10m length is 10m divided by 256. The length of one step is 39mm. This is about 4cm! A crossfade with a smooth, jerking free movement which lasts several minutes is normally not possible because the string will move in steps of 39mm!

Because of this reason we developed with our customers different modes to solve this problem.

First, lets have a look on the calculation of the DMX value for full frame positioning when the device is in linear mode. For example for color 3:

$$DMX\ value\ [percent] = \frac{100 \cdot 3\ (colornumber)}{number\ of\ colors - 1}$$

Under the condition that all frames have the same length.

modes:

The speed mode:

2 DMX-channels.

In this mode one DMX-channel is for position information, the second one is a **speed** information. Here it is possible to determine how fast the color changer must move. The light mixing can store fast or slow fades. This mode is often used in TV studios. Quiet scenes require a quiet movement. Fast color changing can also be done by setting the speed to maximum.

Settings: P12: 00

The time-drive mode:

2 DMX-channels.

Here the first channel represents the position information, the second one represents a **time** in which a move should be done. Here you can determine how long (in min. or sec.) a new positioning should last.

Settings: P12: 01

The one-channel mode:

1 DMX-channel.

One channel for positioning. The speed is calculated from the changing of the value of the position channel.

Settings: P12: 02

A detailed description of the move modes and further programming possibilities are described in the following pages.

Please note: It depends on the programmed mode, if some menu points are reachable. For example if one channel mode is programmed the speed menu is unreachable! The same behavior, if P08 (DMX addresses separated or together) is programmed in together mode. In this case only P01 is reachable, P02 and P03 is not.



P01 DMX-Adress position

At this point the DMX address of the **color changer (position)** can be adapted to the address of the light mixer panel



Range of values: Address 1..512

Operation:

 depress You are now on the menu level. The last adjusted menu point is displayed, e.g.:
menu p02: DMX-Address speed

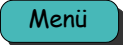
  depress ... until Menu P01 is displayed.

 depress The second line displays the currently adjusted value.

  depress Adjust the desired DMX address.

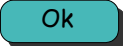
 depress You are back on the menu level.

 depress The equipment is ready for operation.

P02 DMX address speed

At this point the DMX address for the **speed** control of the colour changer can be adapted to the address of the light mixer panel.

If the value is set to 0, the internal adjusted speed of P20 (refer to page 29) will be used. In this case it is possible to operate the color changer without a separate speed channel.



Range of values: 0 no DMX channel for speed (internal speed is used)
1..512 address channel for speed

Operation:

 depress You are now on the menu level. The last adjusted menu point is displayed, e.g.:
menu p01: DMX-Address color changer

  depress ... until Menu P02 is displayed.

 depress The second line displays the currently adjusted value.

  depress Adjust the desired DMX address.

 depress You are back on the menu level.

 depress The equipment is ready for operation.

P03 DMX adress fan intesity

At this point the DMX address for the **fan intensity** control of the colour changer can be adapted to the address of the light mixer panel.

If the value is set to 0, the internal adjusted intensity of P22 (refer to page 30) will be used. In this case it is possible to operate the color changer without a seperate speed channel.



Range of values: 0 no DMX channel for fan intensity (internal intensity is used)
1..512 address channel for fan intensity

Operation:

 depress You are now on the menu level. The last adjusted menu point is displayed, e.g.:
menu p01: DMX-Address color changer

  depress ... until Menu P03 is displayed.

 depress The second line displays the currently adjusted value.

  depress Adjust the desired DMX address.

 depress You are back on the menu level.

 depress The equipment is ready for operation.



P08 DMX addresses together or seperately

To reduce the time for programming it is possible to set only the first address (for position) the others will follow. This means you program only the address for position. For example, if this menu point set to 1 and the position address is set to 139, the speed address is 140 and the fan address is 141. If this menu point is set to 0 you have to program all 3 addresses seperately.

Range of values: 0 adjust all addresses individually
1 adjust only the first address, the others will follow
The menus P02 and P03 are not reachable!

Operation:

 depress You are now on the menu level. The last adjusted menu point is displayed, e.g.:
menu p01: DMX-Address color changer

  depress ... until Menu P08 is displayed.

 depress The second line displays the currently adjusted value.

  depress Adjust the desired value

 depress You are back on the menu level.

 depress The equipment is ready for operation.

P09 Dark color mode speed

Dark colors (like dark blue tones) bleach and shrink very fast with heat. For this colors the dark color mode is available. This means the frame will be moved slowly back and forward for a better heat distribution on the foil. The life time will be enormous increased.

It's up to the user to determine which color should be a dark color. If a color is shrinking and bleaching very fast it is advisable to set this color to a dark color. Note that per dark color the maximum number of colors is decreased by one.

Operation:

1. The concerning color must be twice as long like a normal color (refer to page 7)
2. Set a dark color marker on the concerning color (refer to page 8)
3. P11 (frame by frame or linear Modus) must be set to 1 (refer to page 25)
4. P12 (speed mode) must not be 2 (no 1 channel mode, page 26)

When scanning and memorizing the tape, the device can recognize a dark color because of the longer marker.



At this point you set how fast a selected the dark color frame is to be moved.

Range of values: 3..80

(Note: **5** is default value, suitable for fresnel lenses to be used for quiet theatre and opera use.
40 should be minimum for PAR Lamps)

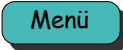
Operation:

 depress You are now on the menu level. The last adjusted menu point is displayed, e.g.:
menu p01: DMX-Address color changer

  depress ... until Menu P09 is displayed.

 depress The second line displays the currently adjusted value.

  depress Adjust the desired value

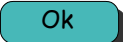
 depress You are back on the menu level.

 depress The equipment is ready for operation.

P10 Setting, Resetting and controlling of the dark colors

A **dark color** is twice as long as a normal color (refer to page 7). If a dark color is selected, the frame is permanently moved in slow motion from the beginning to the end of the frame. This prevents a burn in of the foil and extends the life time of the foil.

The dark color moving speed is set in P09, page 23.

When scanning and memorizing the tape, the device can recognize a dark color because of the longer marker (refer to the marker chapter, page 8).

In function P10 a frame can be set or reset to dark color. These manual changings will be overwritten if a string is new scanned after putting in a cartridge.

All colors except the last can be set to dark color.



Range of values: First to last frame.

Operation:

 depress You are now on the menu level. The last adjusted menu point is displayed, e.g.:
menu p01: DMX-Address color changer

  depress ... until Menu P10 is displayed.

 depress The second line indicates:
f01 ---- frame 1 is no dark color
f01 Dark frame 1 is a dark color

  depress Choose the desired color.

 depress Switch between normal color / dark color.

 depress You are back on the menu level.

 depress The equipment is ready for operation.

P11 Move mode MagMax

At this point you can determine the move mode of the color changer. You can select between **linear** and **frame-by-frame mode**. Linear mode means every position on the tape is reachable. So it is possible to have 2 different colors in the light. Frame-by-frame mode means, only full frames are responsive.

Tip: Even in linear mode the color changer corrects the frame positions by means of the attached aluminium markers, should the string be expanded.



Range of values: 0 linear mode
1 frame by frame mode

Operation:

 depress You are now on the menu level. The last adjusted menu point is displayed, e.g.:
menu p01: DMX-Address color changer

  depress ... until Menu P11 is displayed.

 depress The second line displays the currently adjusted value.

  depress Adjust the desired move mode.

 depress You are back on the menu level.

 depress The equipment is ready for operation.

P12 Speed mode MagMax

At this point you can switch over between the functions of **speed control**, **time control** and **one channel mode**.

In **speed mode** you define via the light mixer panel, how many mm/sec the color tape is moving.

In **time mode** you define how much **time** the process of positioning of the desired position shall require. Time can be adjusted from 0 sec (maximum speed), up to the maximum time defined under **P13**. A time table is shown on the following page.

In **single channel Mode** the speed of color changer is calculated from DMX-signal direct. You need only one channel, but is only practicable with linear mode (P11=0, page 25).

For the **time drive mode** the following equation applies:

$$\text{movingtime} = \frac{\text{DMX}^2 \cdot \text{P13} \cdot 60}{10000}$$

DMX in %
P13 in minutes
moving time in seconds

If you like to calculate from a given moving time the corresponding DMX value you can use the time conversation table on the next page or the following equation:







$$\text{DMX} = \sqrt{\frac{\text{movingtime} \cdot 10000}{\text{P13} \cdot 60}}$$

DMX in %
P13 in minutes
moving time in seconds

Range of values:

0	speed mode
1	time drive mode
2	1 channel mode

Operation:

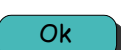
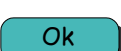
-  depress You are now on the menu level . The last adjusted menu point is displayed, e.g.:
menu p01: DMX-Address color changer
-   depress ... until Menu P12 is displayed.
-  depress The second line displays the currently adjusted value.
-   depress Adjust the desired mode.
-  depress You are back on the menu level.
-  depress The equipment is ready for operation.

Time conversation table time drive mode

Conversion from **moving time** into **DMX** (in%) and reverse.

First determine what maximum moving time you need. For example the fades don't take longer than 10 minutes. So set this time in menu P13, page 28. Choose the corresponding column (10min., 20min. etc.). Choose the desired time for positioning. In the first column you will find the corresponding DMX value.

DMX in %	P13 max time in min.		
	10	20	30
0	0	0	0
1	00:00	00:00	00:00
2	00:00	00:00	00:01
3	00:01	00:01	00:02
4	00:01	00:02	00:03
5	00:02	00:03	00:05
6	00:02	00:04	00:06
7	00:03	00:06	00:09
8	00:04	00:08	00:12
9	00:05	00:10	00:15
10	00:06	00:12	00:18
11	00:07	00:15	00:22
12	00:09	00:17	00:26
13	00:10	00:20	00:30
14	00:12	00:24	00:35
15	00:14	00:27	00:41
16	00:15	00:31	00:46
17	00:17	00:35	00:52
18	00:19	00:39	00:58
19	00:22	00:43	01:05
20	00:24	00:48	01:12
21	00:26	00:53	01:19
22	00:29	00:58	01:27
23	00:32	01:03	01:35
24	00:35	01:09	01:44
25	00:38	01:15	01:53
26	00:41	01:21	02:02
27	00:44	01:27	02:11
28	00:47	01:34	02:21
29	00:50	01:41	02:31
30	00:54	01:48	02:42
31	00:58	01:55	02:53
32	01:01	02:03	03:04
33	01:05	02:11	03:16
34	01:09	02:19	03:28
35	01:14	02:27	03:41
36	01:18	02:36	03:53
37	01:22	02:44	04:06
38	01:27	02:53	04:20
39	01:31	03:03	04:34
40	01:36	03:12	04:48
41	01:41	03:22	05:03
42	01:46	03:32	05:18
43	01:51	03:42	05:33
44	01:56	03:52	05:48
45	02:02	04:03	06:05
46	02:07	04:14	06:21
47	02:13	04:25	06:38
48	02:18	04:36	06:55
49	02:24	04:48	07:12

DMX in %	P13 max time in min.		
	10	20	30
50	02:30	05:00	07:30
51	02:36	05:12	07:48
52	02:42	05:24	08:07
53	02:49	05:37	08:26
54	02:55	05:50	08:45
55	03:02	06:03	09:05
56	03:08	06:16	09:24
57	03:15	06:30	09:45
58	03:22	06:44	10:06
59	03:29	06:58	10:27
60	03:36	07:12	10:48
61	03:43	07:27	11:10
62	03:51	07:41	11:32
63	03:58	07:56	11:54
64	04:06	08:12	12:17
65	04:14	08:27	12:41
66	04:21	08:43	13:04
67	04:29	08:59	13:28
68	04:37	09:15	13:52
69	04:46	09:31	14:17
70	04:54	09:48	14:42
71	05:02	10:05	15:07
72	05:11	10:22	15:33
73	05:20	10:39	15:59
74	05:29	10:57	16:26
75	05:38	11:15	16:53
76	05:47	11:33	17:20
77	05:56	11:51	17:47
78	06:05	12:10	18:15
79	06:14	12:29	18:43
80	06:24	12:48	19:12
81	06:34	13:07	19:41
82	06:43	13:27	20:10
83	06:53	13:47	20:40
84	07:03	14:07	21:10
85	07:14	14:27	21:41
86	07:24	14:48	22:11
87	07:34	15:08	22:42
88	07:45	15:29	23:14
89	07:55	15:51	23:46
90	08:06	16:12	24:18
91	08:17	16:34	24:51
92	08:28	16:56	25:24
93	08:39	17:18	25:57
94	08:50	17:40	26:30
95	09:02	18:03	27:05
96	09:13	18:26	27:39
97	09:25	18:49	28:14
98	09:36	19:12	28:49
99	09:48	19:36	29:24
100	stopped	stopped	stopped

Caution: The color changer doesn't move at DMX value 100% to have the possibility to stop a fade.



P13 Maximum moving time for time drive mode

If you chose **time drive mode** (P12 to 1, page 26) you can program here the maximum moving time for positioning.

Range of values: 0..120 minutes

Operation:

 depress You are now on the menu level. The last adjusted menu point is displayed, e.g.:
menu p01: DMX-Address color changer

  depress ... until Menu P13 is displayed.

 depress The second line displays the currently adjusted value.

  depress Adjust the desired time.

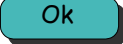
 depress You are back on the menu level.

 depress The equipment is ready for operation.

P20 Internal Speed of color changer



At this point you can define at which speed the color changer should carry positioning, if no DMX channel for speed control is programmed (P02, page 20).

Caution! This speed is only used if P02 is set to 0!

Range of values: 0..255 real DMX value

Operation:

 depress You are now on the menu level. The last adjusted menu point is displayed, e.g.:
menu p01: DMX-Address color changer

  depress ... until Menu P20 is displayed.

 depress The second line displays the currently adjusted value.

  depress Adjust the desired value.

 depress You are back on the menu level.

 depress The equipment is ready for operation.

P22 Internal fan intensity



At this point you can define the fan intensity if no DMX channel for fan control is programmed (P02, page 21).

Caution! This intensity is only used if P03 is set to 0!

Range of values: 0..255 real DMX value

Operation:

 depress You are now on the menu level. The last adjusted menu point is displayed, e.g.:
menu p01: DMX-Address color changer

  depress ... until Menu P22 is displayed.

 depress The second line displays the currently adjusted value.

  depress Adjust the desired value.

 depress You are back on the menu level.









 depress The equipment is ready for operation.

P30 Displaying the DMX value

This function assists you in checking the values transmitted by the light mixer panel. At this point you can quickly detect whether the colour changer is triggered with the correct values. It is possible to check all 512 DMX channels. Note that the value of the address programmed in this menu will be indicated in normal operation. After power up the programmed address in menu P01 (page 19) will be displayed.

Range of values: Address 1..512

Operation:

-  depress You are now on the menu level. The last adjusted menu point is displayed, e.g.:
menu p01: DMX-Address color changer
-   depress ... until Menu P30 is displayed.
-  depress The second line displays the currently adjusted value.
-   depress Adjust the desired address.
-  depress You are back on the menu level.
-  depress The equipment is ready for operation.

P31 DMX Jitter compensation

When the DMX value is varying, these variations can be compensated by the present function. This is helpful if the colour changer is constantly moving between two positions because of variations of the DMX value.

Caution: With this function you limit positioning range of the color changer. For example: If this menu is set to 1, the color changer only starts to move at every second DMX value.

Example:



P31 = 3, present DMX value for position = 10.

The color changer will only start to move again, when the DMX value is either 6 or 14, since all variations around ± 3 values have no effect.

Range of values: 0..10 Bit

Operation:

 depress You are now on the menu level. The last adjusted menu point is displayed, e.g.:
menu p01: DMX-Address color changer

  depress ... until Menu P31 is displayed.

 depress The second line displays the currently adjusted value.

  depress Adjust the desired value.

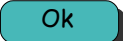
 depress You are back on the menu level.

 depress The equipment is ready for operation.



P32 Selecting the user language

At this point you can choose in which language you want the texts and messages to be displayed.

Range of values: 0 = German
 1 = English

Operation:

 depress You are now on the menu level. The last adjusted menu point is displayed, e.g.:
 menu p01: DMX-Address color changer

  depress ... until Menu P32 is displayed.

 depress The second line displays the currently adjusted value.

  depress Adjust the desired language.

 depress You are back on the menu level.

 depress The equipment is ready for operation.

P34 Reverse DMX time drive



If the time drive mode is selected (P12 = 1, page 26), you can decide either if DMX value 100% is the maximum time or DMX value 0% is the maximum time.

Range of values:

0	100% DMX is maximum time (standart) (slow move at 100%)
1	0% DMX is maximum time (fast move at 0%)

Operation:

 depress You are now on the menu level. The last adjusted menu point is displayed, e.g.:
menu p01: DMX-Address color changer

  depress ... until Menu P34 is displayed.

 depress The second line displays the currently adjusted value.

  depress Adjust the desired value.

 depress You are back on the menu level.

 depress The equipment is ready for operation.

P35 Unit number (Netspider only)

With this function you can set the unit number for Netspider systems.



Range of values: 0..9999

Operation:

 depress You are now on the menu level. The last adjusted menu point is displayed, e.g.:
menu p01: DMX-Address color changer

  depress ... until Menu P35 is displayed.

 depress The second line displays the currently adjusted value.

  depress Adjust the desired unit number.

 depress You are back on the menu level.

 depress The equipment is ready for operation.

Technical data

Dimensions and Weight (without lampholders):

Type MM-MkII-	Weight	Height	Length	Depth	Lighthole	
					front	rear
200	4,8 kg	430	337	74	220	200
250	5,0 kg	470	430	75	260	250
300	7,5 kg	515	526	88	300	300
350	8,9 kg	570	775	88	350	340
430	10,2 kg	633	634	88	430	430
500	10,0 kg	710	680	100	500	500
500-XL	13,5 kg	915	690	100	525 x 680	500 x 680
8-Lite	11,2 kg	910	610	100	430 x 680	430 x 680

Connected loads: 24V DC, max. 1,2 A

Pin assignment:

Data-Power-cable:

4pin XLR

Housing: shield

PIN 1: 0 V

min. cross section 0,75mm²

PIN 2: Data –

min. cross section 0,25mm²

PIN 3: Data +

min. cross section 0,25mm²

PIN 4: +24 V DC

min. cross section 0,75mm²

DMX-data cable:

5pin XLR

PIN 1: 0V

min. cross section 0,25mm²

PIN 2: Data –

min. cross section 0,25mm²

PIN 3: Data +

min. cross section 0,25mm²

PIN 4: not connected

min. cross section 0,25mm²

PIN 5: not connected

min. cross section 0,25mm²

Caution: To comply EMV rules our equipment has to be connected with shielded cables. This also for reliability of our equipment.

The DMX wires must be twisted pair and shielded separately.

Factory presets

Menu	Description	Value	Remark
P01	DMX address position	1	0%: Color 1 100%: last color
P02	DMX address speed	2	0%: no speed 100%: full speed
P03	DMX adress fan	3	0%: no speed 100%: full speed
P10	Manual setting of dark colors	no dark colors	
P11	move mode color changer	1	Frame by frame
P12	Speed mode color changer	1	Time drive mode
P13	Maximum time for time drive mode	10 minutes	
P20	Internal speed	255	
P22	Internal fan intensity	255	
P30	DMX tester	1	
P31	DMX Jitter compensation	0	
P32	Language	0	German
P34	Reverse DMX time drive	0	No Reverse
P35	Unit number Netspider	0	

Error Messages / Malfunctions

- No display after power up.

The device houses a slow-blow fuse for feeble currents of 3.15 A protecting the equipment of wrong polarities on the supply line. When the fuse is blown, cable and polarity have absolutely be checked (pin1 = 0 V, pin 4 = +24V).

- E20 The DMX control signal does not arrive at the device.

- Check the DMX signal supply to the power supply unit. LED „DMX okay“ must light.
- The data lines (Pin2 and/or Pin3) in the cable leading to the color changer is defective.
- The controlling unit is not yet operative.

- E21 The polarity of the DMX signal is interchanged

- Check the 4pin supply cable(s) if pins 2 and 3 are interchanged.
- Check the 5pin cable to the power supply if pins 2 and 3 are interchanged.

- E23 DMX noise

- This malfunction may come up in case of major line length or in case of bad signal quality. Check cables and connections.
- Check out if a terminating resistor (470 Ohm) can help.

- E28 Eprom Error

- After power up the program memory is checked. If any error is detected, the above message will be displayed. Notify company Licht-Technik in this case.

- E29 RAM-Error

- After power up the RAM memory is checked. If any error is detected, the above message will be displayed. Notify company Licht-Technik in this case.

- E30 Motor blocked

- Check if any foreign object is in the device.
- Make sure that the drum drive is running smoothly.
- Connections of motor or potentiometer were possibly interchanged when motor or potentiometer was replaced.

- E40 Cartridge is not memorized

- The inserted cartridge is not memorized. It is possible that the cartridge was changed when the color changer was switched off.

- E41 Memorization of cartridge is not possible

- Remove the cartridge, position the color tape of the cartridge to its middle position (the center color). Insert the cartridge again and lock it. Should the error occur again proceed as follows:
- The color tape is too long. Make sure the tape does not exceed the maximum length. (Refer to page 7, dimensions of color tape).
- There may be foreign particles in the sensor detecting the aluminium markers. Remove these particles and insert the cartridge again.

Note: Never write down anything (e.g. color numbers) onto the bottom of the tape, because the writing will move through the sensor and may be detected as markers!

Warranty

The warranty for our products is 2 years. It comprises any repair of failures – free of charge – which can be proved to result from defects of fabrication.

Warranty expires when:

- the device was modified or attempted to be repaired
- damages were caused by the intervention of foreign persons
- damages are due to noncompliance with the operating instructions
- the device was connected to an incorrect voltage or incorrect type of current
- the device was incorrectly operated or when damages were caused by negligent handling or misuse

All maintenance and servicing works related to the product must be carried out by the company *Licht-Technik*. *Licht-Technik* shall not assume any liability for losses or damages of any kind being the results of inexpert servicing.

Further information

This document and the information contained therein are subject to copyright and neither the whole nor any part of it may, and this is also valid for the described product, be reproduced, copied or recorded in any form without the prior written authorization of *Licht-Technik Vertriebs GmbH*.

The products of *Licht-Technik GmbH* are subject to constant development. Therefore *Licht-Technik* reserves the right to modify components, motors and also technical specifications any time and without prior notice.

Declaration of conformity

1. **Type of device/product** Color changer MagMax
2. **Name and address of manufacturer** Licht-Technik Vertriebs GmbH
Osterwaldstraße 9-10
80805 München
3. **The manufacturer is responsible for this declaration**
4. **Item of declaration** MM200 / MM250 / MM300 /MM350 / MM430
MM500
MM Mk II 200 / MM MkII 250 / MM MkII 300 / MM
MkII 350 / MM MkII 430

5. **The described item is conform to the following guidelines/regulations**

RICHTLINIE 2014/30/EU DES EUROPÄISCHEN PARLAMENTS UND DES RATES vom 26. Februar 2014 zur Harmonisierung der Rechtsvorschriften der Mitgliedstaaten über die elektromagnetische Verträglichkeit

RICHTLINIE 2011/65/EU DES EUROPÄISCHEN PARLAMENTS UND DES RATES vom 8. Juni 2011 zur Beschränkung der Verwendung bestimmter gefährlicher Stoffe in Elektro- und Elektronikgeräten

6. **Applied and conform to harmonized standards in particular**

DIN EN 55015; VDE 0875-15-1:2016-04 - Grenzwerte und Messverfahren für Funkstörungen von elektrischen Beleuchtungseinrichtungen und ähnlichen Elektrogeräten (CISPR 15:2013 + IS1:2013 + IS2:2013 + A1:2015); Deutsche Fassung EN 55015:2013 + A1:2015

DIN EN 61547; VDE 0875-15-2:2010-03 Einrichtungen für allgemeine Beleuchtungszwecke – EMV-Störfestigkeitsanforderungen (IEC 61547:2009); Deutsche Fassung EN 61547:2009

7. **Not applicable**

8. **This declaration is invalid if the device is changed technically and/or unintended use.**

Signed for

Licht-Technik Vertriebs GmbH

Place and date of description

München 28.9.2017



Uwe Hagenbach (Geschäftsführer)

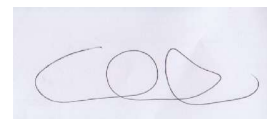

Bernhard Grill (Geschäftsführer)