



Dimmer Shutter

with integrated power supply

Dimmer Shutter
for HMI daylight lamps

Functional description Shutter V3.29

Fabrication and Marketing
Licht-Technik
Hagenbach & Grill
Osterwaldstr. 9-10 80805 München
Tel. 089-360528-0 Fax 089-360528-30
E-Mail: info@Licht-Technik.com
Last updated on: 04/07/19 Rev.: 1.01

Caution! Operate the device only after having read and **understood** the operating instructions!

Dimmer Shutter

The **Shutter** is a versatile, high speed Dimmer for HMI daylight lamps. It is also suitable for tungsten light to get a fast blackout.

The shutter has been designed for the specific needs of **theaters, opera** houses and professional hire companies of lighting equipment. The use of modern microprocessor techniques enables a quick and safe processing of all applications carried out with our shutter.

The Shutter700 is very well suited for PAR lamps like the ARRI-MAX™. Because of high temperature bearings, special powder coated blades and an active cooling we can offer a shutter for an 18kW PAR light.

The **DMX-512** (USITT 1990) control signal and the distribution voltage is supplied by our splitbox PS104 or PS204. An optional combination of 230 VAC supply and DMX triggering is also possible.

The DMX triggering offers a lot of user possibilities. Via a second DMX channel, the opening or closing time can be adjusted within a range of ms up to hours. Thus flashes of 200ms can be easily realized as well as sunrises of a length of 2 hours for example.

We provide 4 different operation modes. **Speed Mode** with two DMX-channels, **time drive mode** with 2 DMX-channels, **16 Bit DMX-mode** with 2 DMX-channels and **1 Channel mode**.

In **speed mode** you can determine how fast the blades should move. With a second DMX channel you set the shutter speed from 0% to 100%.

In **time drive** mode you can determine in which time a fade should be done. For example, you set a time of 1 Sec. or 20 Sec.. The desired time is programmed via a second DMX channel.

Because of the low resolution of the DMX protocol, only 256 (8-Bit) different steps are normally possible. If fades over 10 min. are desired, these steps can be seen as steps in brightness. With our kind of control, you determine a position and a time in which this position should be reached. After that the shutter itself calculates the speed which is necessary and moves the blades in many thousands steps which cannot be seen by the human eye. The time is selectable via DMX between 1 Sec. and 120 min.. So you can realize very slow fades up to 2 hours or very fast flashes in 0,2 Sec. (Flash-function).

Because of this low DMX resolution we developed for modern Light control desks the **16-Bit mode**. The control panel has to send the position information over 2 DMX channels. In this mode the Shutter can use its high internal resolution. Because of the 16-Bit resolution, the control board can use 65536 (16-Bit) different „Brightnesses“. Therefore, no light flickering can be seen, also when the shutter is very slow moving.

In 1 channel mode, the device calculates its speed itself from the changing of the position channel. This means, as faster the position is changing the faster is the speed of the blades. This is a nice feature, because you need only 1 channel and you can realize slow or fast fades without any visible steps.

The built in **32-Bit processor** provides high throughput of the computer, quick positioning and uncomplicated handling. Even if several shutters are triggered, the precise control system provides high synchrony of the individual shutters.

Another feature is the **light linearisation**, that means, at a DMX value of 50% the light output is also 50%.

The lightened **LCD display** leads the user intuitively in plain text through the programming menu. The language can be set either to German or to English.

We would like to express our special thanks to Max Keller, Gundram von Löffelholz and Tobias Löffler of the Münchner Kammerspiele and also to Peter Halbsgut from Munich Operahouse whose ideas, creativity and criticism represented a valuable contribution in the development of the DARK VADER and Shutter 80.

Table of content

Operating and safety instructions.....	6
Cabling.....	7
Getting started.....	8
User interface.....	8
Display lighting ON/OFF.....	8
Checking basic parameter.....	9
Setting to default values.....	9
Operation modes.....	10
P01 DMX adress shutter.....	12
P02 DMX adress speed.....	13
P15 Operation mode.....	14
Conversation table time drive mode (mode 2).....	15
P16 Maximum moving time for time drive mode.....	16
P18 Middle position compensation.....	17
P21 Internal speed shutter.....	18
P30 Show DMX.....	19
P31 DMX Jitter Compensation.....	20
P32 Selecting the user language.....	21
P34 Reverse DMX time drive.....	22
P35 Unit number (Netspider only).....	23
Technical data.....	24
Factory presettings.....	25
Error messages / failures.....	26
Warranty.....	27
Further information.....	27
EC Declaration of Conformity.....	28

Operating and safety instructions

Before opening the housing disconnect the device from the mains !!!

Do not try in any case to touch the electronic through openings, also with any objects. This can cause an electrical accident that can lead to death!

Please note: The **switching** or rising/falling from one input voltage range to another during operation can lead to damage of the device!

When using a generator, first start the generator and wait for stable mains supply voltage! After that switch on the power supply

When using a generator, leave the device switched off until the mains voltage and frequency of the generator is stable. Starting the generator with switched on device will damage the device!!!

The **Shutter** must only be operated when being in the operating position provided for this purpose. The motor and gearbox unit must not be at the top position.

Admissible ambient temperature: 0..+55 °Celsius

The vents must not be blocked or covered.

The equipment is designed to be used in dry and clean rooms.

The shutter must be kept dry. In case of water condensation a waiting period of 2 hours is necessary until acclimatisation is reached.

Observe the maximum load of the fastening spigots. The maximum load will be increased by the additional weight of the shutter.

Power supply via the DATA Power input of the shutters must only be realized via power supplies which are authorized by *Licht-Technik* (see electrical separation from the mains).

The device is getting very hot during operation. Let it cool down for at least 1 hour before touching it.

Check the right fixture of the shutter on the lamp.

Use a safety belt.

Attention:

Before starting the equipment the user must check the usefulness of the device for its intended use.

We reject every **liability**:

- Damages and indirect damages or every kind of costs, which result from the use of Licht-Technik products.
- Any damages which result from negligence, improper use and setup, wrong setting into operation and use, ignoring of valid safety regulations, unsuitable use, bad maintenance of Licht-Technik products.

When it has to be assumed that a safe operation is no longer possible, the equipment must be switched off immediately and be secured against unintended operation.

This is the case when:

- the device shows visible damages
- the device is not functional
- parts of the device are loose or slackened
- connecting lines show visible damages

Prior to starting the equipment the user must check the usefulness of the device for its intended purpose. In particular, Licht-Technik shall decline any liability for damages of the equipment as well as for consequential damages resulting of the device being used inappropriately, of inexperienced installation, incorrect starting, use and noncompliance with the valid safety regulations.

Cabling

Caution!

Please read the operating and safety instructions on page 6 (continuing) before cabling!

Make sure that the device is **switched off** before cabling!

The standardized DMX-Signal is based on industrie's RS485 Interface. It is designed for maximum lengths up to 1200m. This length is under condition in theatre or studio normally not possible. As a result of internal tests we recommend a maximum length of 200m (**only DMX, 5PIN**).

The maximum length of a Output (**Data Power, 4PIN**) must not exceed 80m because of the voltage drop.

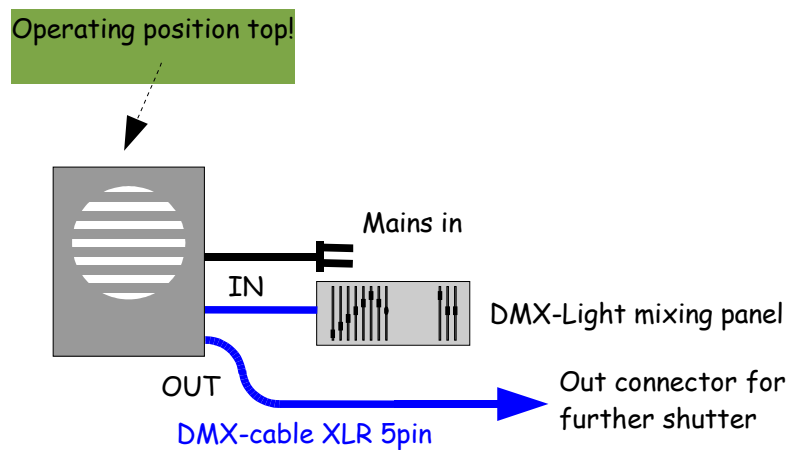

Switch off the device. Connect the light mixer panel and the dimmer shutter with a 5PIN XLR-DMX-cable. Connect the mains input.

The last device of a serie should be connected with a terminating impedance (470 Ohm). It is plugged into the OUT connector of the last device of a row.

Getting started

Please read first the operating and safety instructions on page 6. After that cable the shutter like illustrated on page 8. Observe the valid safety regulations for the mains input.

After power up, the shutter quickly moves to both limit stops (initialisation) and will then move to the position given by the DMX value.

The first line of the LCD display scrolls the *Licht-Technik* moving text. The second line indicates the DMX address and the transmitted value (real DMX value 0..255). For operation you should program the desired DMX address(es). This is possible in Menu P01, P02 and P15. Refer to page 11 for operation modes. Now you can control the shutter via the DMX control panel.

For further programming possibilities, please refer to the following pages.

User interface

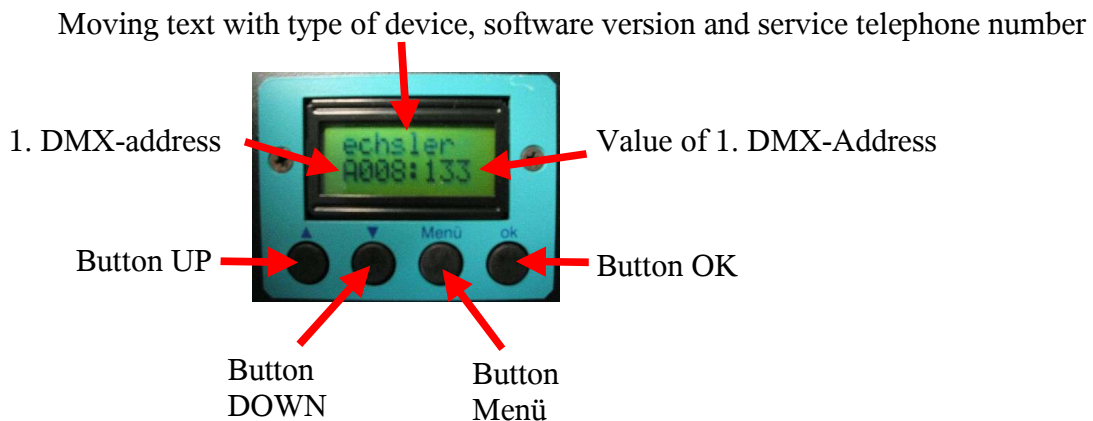



Display lighting ON/OFF

In normal operation the LCD backlight is switched off to avoid a disturbing light. Only if an error occurs or during programming the light will be switched on automatically. The user can also switch it on manually to see what is indicated.

Condition: Color changer is on working level (default state)

Operation:

-  depress. Display light **ON**
-  depress. **Display light OFF**

Checking basic parameter

With this function you can quick check some basic parameters. Here you can get an quick overview of what is programmed.

Condition: Color changer is on working level.

Operation:



depress.

The first line indicates the current operaton mode, e.g.:
mode 01

The second line shows the current DMX addresses
009 010



depress again.

Address and DMX-value is displayed again e.g.
A001:023
You are back at working level.

Setting to default values

With the following handles the equipment can be put back to factory presettings (refer to page 27). This is an interesting feature for rental houses which can reset the device after a order.

Operation:

Power off MagMax first



depress and hold.

Power on MagMax.



release. Display shows ok for presets

Ok

if you like to store default values
any other key for doing nothing

Operation modes

In teamwork with our customers we developed different operation modes. So we can support all requirements of a modern shutter.

The speed mode:

2 DMX channels.

In this mode one DMX channel is for positioning of the blades, the other one is the speed information (how fast the positioning should happen). Use it if you like to move the blades fast and slow. It is also possible to set the second channel to a fixed speed (internal speed).

Settings: P15: 00
P01: DMX adress for position of the blades
P02: DMX adress for speed control
(select DMX value for speed at your lightcontrol:
0% means no speed; 100% means full speed)

The time drive mode:

2 DMX channels.

First channel is for position of the blades. The second channel is the time (not speed!) in which the positions should be reached. You have the possibility to open/close the shutter in certain time (selected with 2nd DMX-channel) Often used in theatre houses where you need to control the time for opening and closing the blades. There is no flickering of the light, because the Shutter moves without any visible steps.

Settings: P15: 01
P16: e.g. 10 (= maximum fade time in minutes (here 10)).
P01: DMX adress for position of the blades
P02: DMX adress for the fade time
(select DMX value for time in time conversion table (page 16),
inside you find the corresponding DMX-value.).

The 16-Bit Mode:

2 DMX channels.

Both channels are used for positioning of the blades. The second channel is fine positioning. This mode is only supported by modern light consoles.

Settings: P15: 02
P01: DMX adress shutter
(the following channel will be automatically used for fine positioning)

The 1 channel mode:

1 DMX channel

One channel for blade positioning. The moving speed is internally calculated from the position channel.

Settings: P15: 03
P01: DMX adress shutters

A detailed description of the operating modes and further programming possibilities, please refer to the following pages.

The flash function:

2 DMX channels.

One Channel for blade position

One Channel as time for the time drive mode

Settings: P15: 01
P17: 01
P01: DMX adress shutter
P02: DMX adress time **Must send 0!**

This function is not available for the **SH700!**









Please note: It depends on the programmed mode, if some menu points are reachable. For example if one channel mode is programmed the speed menu is unreachable! The same behavior, if P08 (DMX addresses seperated or together) is programmed in together mode. In this case only P01 is reachable, P02 is not.

P01 DMX address shutter

At this point the DMX address of the shutter can be adapted to the address of the light mixer panel.

Range of values: Address 1..512

Operation:

-  depress Now you are at the menu level. The last adjusted menu point is displayed, e.g.:
MENU P02: DMX-Adress speed
-   depress ... until menu P01 is displayed.
-  depress The second line indicates the currently adjusted value.
-   depress Adjust the desired address.
-  depress You are back at the menu level.
-  depress The equipment is ready for operation.

P02 DMX adress speed







Only available in operation mode 0 and 1 (set the operation mode in P15).

At this point the DMX address for speed control of the shutter can be adapted to the address of the light mixer panel.

When **value 0** is entered there will be no speed control via the DMX light mixer panel. The shutter moves with the speed indicated in **P21**. In this case the shutter moves with fixed speed, programmend in **P21** (You need one channel less).

Range of values: Adress 0 no DMX channel for speed
 1..512 DMX address for speed

Operation:

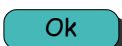
-  depress Now you are at the menu level. The last adjusted menu point is displayed, e.g.:
MENU P01: DMX-Adress shutter
-   depress ... until menu P02 is displayed.
-  depress The second line indicates the currently adjusted value.
-   depress Adjust the desired address.
-  depress You are back at the menu level.
-  depress The equipment is ready for operation.

P15 Operation mode

At this point you switch to the different operation modes of the shutter.

Mode 0 : **Speed mode**, 2 Channels.

One channel for position, an other channel for **speed** from 0 .. 100% to move to the given position.

Mode 1 : **Time drive mode**, 2 channels.

One channel for position, an other channel represents the **time** to move on the given position. (refer to next page for time table).

$$\text{Moving time} = \frac{DMX^2 \cdot P16 \cdot 60}{10000}$$

DMX in %
P16 in minutes
Moving time in seconds

If you like to calculate a DMX value from a given moving time, you can use the time conversion table on the next page, or you can use this formula:

$$DMX = \sqrt{\frac{\text{moving time} \cdot 10000}{P16 \cdot 60}}$$

DMX in %
P13 in minutes
Moving time in seconds



Mode 2 : **16 Bit mode**, 2 channels Kanäle. Both channels for position of the blades.
The 2nd channel is fine position.

Mode 3 : **One channel mode**. One channel for position. The speed is calculated by the shutter.

Range of values: 0 = Speed mode
1 = Time drive mode
2 = 16-Bit mode
3 = One channel mode

Operation:

 depress Now you are at the menu level. The last adjusted menu point is displayed, e.g.:
MENU P01: DMX-Adress shutter

  depress ... until menu P15 is displayed.

 depress The second line indicates the currently adjusted value.

  depress Adjust the desired value.

 depress You are back at the menu level.

 depress The equipment is ready for operation.

Conversation table time drive mode (mode 2)

Calculation of moving time from DMX value (in %).

First determine the maximum fading time of your fades. E.g. 10min. Program this time in Menu P16. In the following time table go to column 10min. Go to the line where the right fade time is in. In the first column you can see the corresponding DMX value in %. This is the value you have to send on the speed channel. The next positioning will be done in the chosen moving time.

DMX value	Time control: Set maximum moving time in P16				
in %	10 min.	20 min.	30 min.	60 min.	120 min.
0	0	0	0	0	0
1	0	0	0	0	1
2	0	0	1	1	3
3	1	1	2	3	6
4	1	2	3	6	12
5	2	3	5	9	18
6	2	4	6	13	26
7	3	6	9	18	35
8	4	8	12	23	46
9	5	10	15	29	58
10	6	12	18	36	72
15	14	27	41	81	162
20	24	48	72	144	288
25	38	75	112	225	450
30	54	108	162	324	648
35	74	147	221	441	882
40	96	192	288	576	1.152
45	121	243	364	729	1.458
50	150	300	450	900	1.800
55	182	363	545	1.089	2.178
60	216	432	648	1.296	2.592
65	254	507	761	1.521	3.042
70	294	588	882	1.764	3.528
75	338	675	1.013	2.025	4.050
80	384	768	1.152	2.304	4.608
85	433	867	1.300	2.601	3.901
90	486	972	1.458	2.916	4.374
95	541	1.083	1.624	3.249	6.498
100	No move	No move	No move	No move	No move

Important !!!

If the time is set to 100% (DMX value 255), the shutter doesn't move to allow stops during a fade over!









P16 Maximum moving time for time drive mode

When time control mode is selected (**P15** set to **value 1**) you can enter the maximum moving time for a positioning process.

Condition: P15 set to 1

Range of values: 1..120 minutes

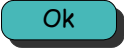
Operation:

-  depress Now you are at the menu level. The last adjusted menu point is displayed, e.g.:
MENU P01: DMX-Adress shutter
-   depress ... until menu P16 is displayed.
-  depress The second line indicates the currently adjusted value.
-   depress Adjust the desired value.
-  depress You are back at the menu level.
-  depress The equipment is ready for operation.









P17 flash function On / Off

This menu is only available if menu P15, operation mode, page 15, is set to time drive mode. In addition the time channel has to send 0! Refer also to page 12!

Condition: P15 set to 1

Range of values: 0: flash function OFF
1: flash function ON

Operation:

-  depress Now you are at the menu level. The last adjusted menu point is displayed, e.g.:
MENU P01: DMX-Adress shutter
-   depress ... until menu P16 is displayed.
-  depress The second line indicates the currently adjusted value.
-   depress Adjust the desired value.
-  depress You are back at the menu level.
-  depress The equipment is ready for operation.







This function is not available for the **SH700!**

P18 Middle position compensation

With this function it possible to adjust the opening position of the blades.

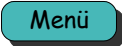
Range of values: -999 .. +999 Steps

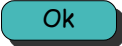
Operation:

-  depress Now you are at the menu level. The last adjusted menu point is displayed, e.g.:
MENU P01: DMX-Adress shutter
-   depress ... until menu P18 is displayed.
-  depress The second line indicates the currently adjusted value.
-   depress Adjust the desired value.
-  depress You are back at the menu level.
-  depress The equipment is ready for operation.

P21 Internal speed shutter

At this point you define at which speed the shutter shall carry out positioning processes when no DMX channel for speed control was programmed (**P02** set to **value 0**). Remember that this value is related to the **speed mode** and the **time drive mode**. When time control was selected (**P15** set to **1**) this value is a time parameter. When speed mode was selected (**P15** set to **0**) this value indicates a speed.









Condition: **P15** set to 0 or 1

(16 bit mode and one channel mode don't need any speed information)

Mit der internen Geschwindigkeit wird nur dann verfahren, wenn **P02** auf **0** ist.

Range of values: 0..255

Operation:

-  depress Now you are at the menu level. The last adjusted menu point is displayed, e.g.:
MENU P01: DMX-Adress shutter
-   depress ... until menu P21 is displayed.
-  depress The second line indicates the currently adjusted value.
-   depress Adjust the desired speed/time.
-  depress You are back at the menu level.
-  depress The equipment is ready for operation.









P30 Show DMX

This function assists you in checking the values transmitted by the light mixer panel. At this point you can quickly detect if the shutter is triggered with the correct values.

Please notice, that the channel and its value selected here will be the one which will be indicated in normal operation mode!

Range of values: Address 1..512

Operation:

-  depress Now you are at the menu level. The last adjusted menu point is displayed, e.g.:
MENU P01: DMX-Adress shutter
-   depress ... until menu P30 is displayed.
-  depress The second line indicates the currently adjusted value.
-   depress Adjust the desired DMX channel.
-  depress You are back at the menu level.
-  depress The equipment is ready for operation.

P31 DMX Jitter Compensation

When the DMX value is varying, these variations can be compensated by the present function. This is helpful when the blades of the shutter are vibrating because of variations of the DMX value.









Caution! This function will limit the positioning range. E.g. when the value at this point is set to 1, only every second DMX value will move the shutter.

Example: P31 = 3, current DMX position = 10

The colour changer will only start to move again when the DMX value is either 6 or 14, since all variations around ± 3 bits have no effect!

Range of values: 0..10 Bit

Operation:







-  depress Now you are at the menu level. The last adjusted menu point is displayed, e.g.:
MENU p01: DMX-Adress shutter
-   depress ... until menu P31 is displayed.
-  depress The second line indicates the currently adjusted value.
-   depress Adjust the desired value.
-  depress You are back at the menu level.
-  depress The equipment is ready for operation.

P32 Selecting the user language

At this point you can choose in which language you want the texts and messages to be displayed.

Range of values: 0 = German
1 = English

Operation:

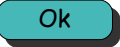
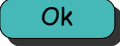
-  depress Now you are at the menu level. The last adjusted menu point is displayed, e.g.:
MENU P01: DMX-Adress shutter
-   depress ... until menu P32 is displayed.
-  depress The second line indicates the currently adjusted value.
-   depress Adjust the desired language.
-  depress You are back at the menu level.
-  depress The equipment is ready for operation.

P34 Reverse DMX time drive









Only for **time drive mode**. With this feature it is possible to reverse the function of the time control fader.

Normal operation is 0% DMX-value at the time channel is full speed (0 % = 0 sec time)
Reverse operation is 0% DMX-value is max. time (selectet at P16)

Condition: P15 is set to 1 (time drive mode)

Range of values: 0 = DMX 100% is max. time (Standard, slow move at 100%)
1 = DMX 0% is max. time (slow move at 0%)

Operation:







-  depress Now you are at the menu level. The last adjusted menu point is displayed, e.g.:
MENU P01: DMX-Adress shutter
-   depress ... until menu P34 is displayed.
-  depress The second line indicates the currently adjusted value.
-   depress Adjust the desired value.
-  depress You are back at the menu level.
-  depress The equipment is ready for operation.

P35 Unit number (Netspider only)

Here you can set the unit number for netspider systems. This number is only necessary in Netspider systems. In normal DMX systems, this number has absolutely no effect.

Range of values: 0..9999

Operation:

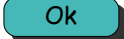
-  depress Now you are at the menu level. The last adjusted menu point is displayed, e.g.:
MENU P01: DMX-Adress shutter
-   depress ... until menu P35 is displayed.
-  depress The second line indicates the currently adjusted value.
-   depress Adjust the desired value.
-  depress You are back at the menu level.
-  depress The equipment is ready for operation.

Technical data

Weight and dimensions (mm):

Type	Length [cm]	Height [cm]	Depth [cm]	Weight [kg]
SH430	58,0	65,0	10,0	10,5
SH630	75,0	90,0	10,0	14,5

Mains input: 90 – 264 VAC, 47 – 440 Hz

DC part: 24 VDC, max. 1,6 A, max. 110W

Pin assignment:

Data-Power-cable: 4pin XLR

Housing: shield

PIN 1:	0 V	cross section min. 0,75mm ²
PIN 2:	Data –	cross section min. 0,25mm ²
PIN 3:	Data +	cross section min. 0,25mm ²
PIN 4:	+24 V DC	cross section min. 0,75mm ²

Datenleitung: 5pin XLR

PIN 1:	shield	cross section min. 0,25mm ²
PIN 2:	Data –	cross section min. 0,25mm ²
PIN 3:	Data +	cross section min. 0,25mm ²
PIN 4:	Not connected	cross section min. 0,25mm ²
PIN 5:	Not connected	cross section min. 0,25mm ²

Please note: To avoid electrical and magnetical radio interferences, please use only screened cables. This improves also a safe operation of the devices.

The DMX wires must be twisted pair and shielded seperately.

Factory presettings

Menu	Meaning	Value	Remark
P01	DMX Addr. position	1	0%: closed 100%: open
P02	DMX Addr. Speed	0	0%: no speed 100%: full speed
P15	Operating mode	3	1 channel
P16	Max. time for time drive mode	10 minutes	
P17	Flash function On / Off	0	Off
P18	Middle position compensation	Individual	
P21	Internal speed shutter	255	Full speed
P30	DMX tester	1	
P31	DMX Jitter correction	0	
P32	User language	0	English
P34	Reverse DMX time drive	0	No reverse
P35	Unit number Netspider (Netspider systems only!)	0	

If a fan is obstructed, the speed always set to 100%. This function can not be controlled by DMX.

Error messages / failures

– No display messages after power up

The equipment houses a slow-blow fuse for feeble currents of 3.15 A protecting the equipment of wrong polarities on the supply line. When fuse is blown, cable and polarity have to be checked (Pin1 = 0V, Pin4 = +24V).

- E20 The DMX control signal does not arrive the device.

- Check the DMX supply to the power supply unit (splitbox). DMX Ok LED must light.
- Check if one or more pins of the input cable to the Shutter are broken.
- The light mixer panel is not operative.

– E21 The polarity of the DMX signal is interchanged

- Check input line if Pin 2 and Pin 3 are interchanged.
- Check 5pin DMX supply cable to the Power supply unit (splitbox).

- E23 DMX noise

- This malfunction may come up in case of major line lengths or in case of bad signal quality. Check the cables and connections.
- Try out, if a terminating resistor at the last device in a row can help.

- E28 Eprom error

- After power up, the program memory is checked. If any error is detected, this error message is displayed. Notify company *Licht-Technik* in this case!

- E29 RAM error

- After power up, the RAM memory is checked. If any error is detected, this error message is displayed. Notify company *Licht-Technik* in this case!

– E31 Motor is blocked

- Check, if there is any foreign object inside the device
- Check, if the drive can move easily
- Check cable connections to motor and potentiometer connections are reversed, if motor or potentiometer was changed

Warranty

The warranty for this shutter is 24 months. It comprises any repair of failures -free of charges- which can be proved to result from defects of fabrication.

Warranty expires when:

- the device was modified or attempted to be repaired
- damages were caused by the intervention of foreign persons
- damages are due to noncompliance with the operating instructions
- the device was connected to an incorrect voltage or incorrect type of current
- the device was incorrectly operated or when damages were caused by negligent handling or misuse.

Further information

This document and the information contained therein are subject to copyright and neither the whole nor any part of it may, and this is also valid for the described product, be reproduced, copied or recorded in any form without the prior written authorization of *Licht-Technik Vertriebs GmbH*.

The products of *Licht-Technik GmbH* are subject to constant development. Therefore *Licht-Technik* reserves the right to modify components, motors and also technical specifications any time and without prior notice.

All maintenance and servicing works related to the product must be carried out by the company *Licht-Technik*. *Licht-Technik* shall not assume any liability for losses or damages of any kind being the results of inexperienced servicing.

EC Declaration of Conformity

1. **Type of device/product** Dimmer Shutter Dark Vader
2. **Name and address of manufacturer** Licht-Technik Vertriebs GmbH
Osterwaldstraße 9-10
80805 München
3. **The manufacturer is responsible for this declaration**
4. **Item of declaration** SH-430-04-DE-N, SH-630-03-DE-N
5. **The described item is conform to the following guidelines/regulations**

RICHTLINIE 2014/30/EU DES EUROPÄISCHEN PARLAMENTS UND DES RATES vom 26. Februar 2014 zur Harmonisierung der Rechtsvorschriften der Mitgliedstaaten über die elektromagnetische Verträglichkeit

RICHTLINIE 2014/35/EU DES EUROPÄISCHEN PARLAMENTS UND DES RATES vom 26. Februar 2014 zur Harmonisierung der Rechtsvorschriften der Mitgliedstaaten über die Bereitstellung elektrischer Betriebsmittel zur Verwendung innerhalb bestimmter Spannungsgrenzen auf dem Markt

RICHTLINIE 2011/65/EU DES EUROPÄISCHEN PARLAMENTS UND DES RATES vom 8. Juni 2011 zur Beschränkung der Verwendung bestimmter gefährlicher Stoffe in Elektro- und Elektronikgeräten

6. **Applied and conform to harmonized standards in particular**

DIN EN 55015; VDE 0875-15-1:2016-04 - Grenzwerte und Messverfahren für Funkstörungen von elektrischen Beleuchtungseinrichtungen und ähnlichen Elektrogeräten (CISPR 15:2013 + IS1:2013 + IS2:2013 + A1:2015); Deutsche Fassung EN 55015:2013 + A1:2015

DIN EN 61547; VDE 0875-15-2:2010-03 Einrichtungen für allgemeine Beleuchtungszwecke – EMV-Störfestigkeitsanforderungen (IEC 61547:2009); Deutsche Fassung EN 61547:2009

DIN EN 60598-1; VDE 0711-1:2015-10 – Leuchten – Teil 1: Allgemeine Anforderungen und Prüfungen (IEC 60598-1:2014, modifiziert); Deutsche Fassung EN 60598-1:2015

7. **Not applicable**

8. **This declaration is invalid if the device is changed technically and/or unintended use.**

Signed for

Licht-Technik Vertriebs GmbH

Place and date of description

München 6.9.2017



Uwe Hagenbach (Geschäftsführer)



Bernhard Grill (Geschäftsführer)